



AMALGAMATED CONCRETE

INDUSTRIAL PRODUCTS

RIB AND BLOCK / BLOCK AND BEAM

Benefits of the Rib and Block Slab System

- ✚ This application is suitable in all types of buildings where suspended floors are required.
- ✚ Ideal for residential houses
- ✚ Rib and Block are quicker and less costly to build than traditional shuttered concrete.
- ✚ The best solution for complicated slabs with skylight openings and cantilevers.
- ✚ Simple and quick to install even with unskilled labor.
- ✚ Ideal composite action between lattice lintels and cast-in-situ concrete, optimizing strength / material requirement for cost saving.
- ✚ Rib and Block slabs are assembled by hand.
- ✚ No cranes or other machinery required whereas hollow core slabs are very heavy and require cranes to assemble.

SS 120



18.5 kg

SS 200



26 kg

SS 290



37 kg

Dimensions

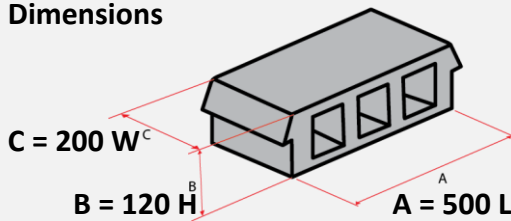

Dimensions

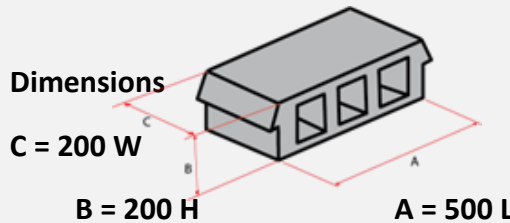

Dimensions

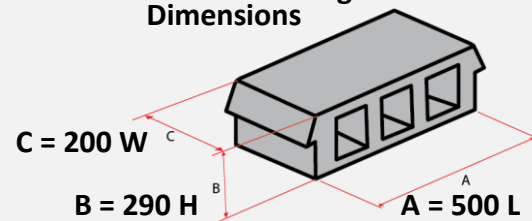

Dimensions

Rib & Block/ Suspended Floor in Use



21 KG PER METER

$D = 50\ W$

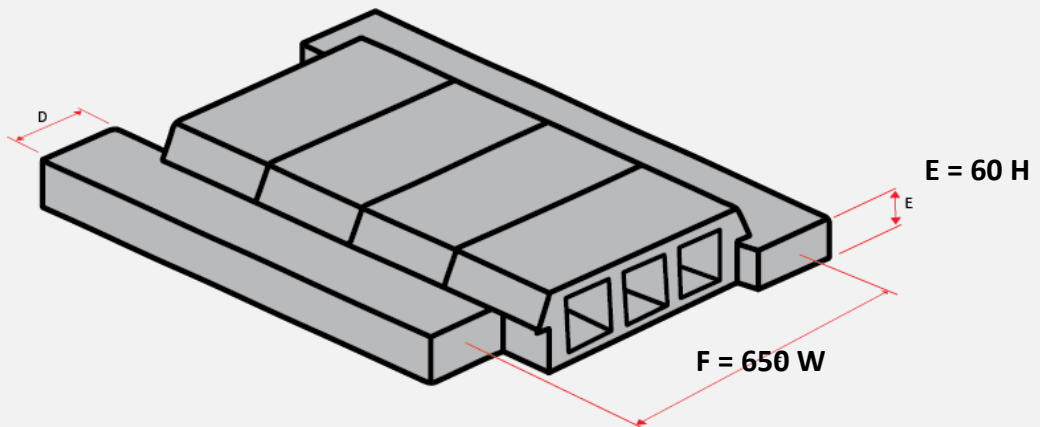

REF 193 = 20 kg

Y12 = 5 kg

For orders: Tanja Du Plessis

082 801 4081

tanja@amalgamatedconcrete.co.za



AMALGAMATED CONCRETE

BLOCKS AND BRICKS

M100 BLOCK



Dimensions:	390 [L] x 88[W] x 190 [H]
Strength:	3.5Mpa
Blocks per m ² :	12.5
Weight per block:	11.5kg
Bricks per pallet:	150 = 1725 KG PER PALLET – 18 pallets per load

M140 BLOCK



Dimensions:	390 [L] x 140 [W] x 190 [H]
Strength:	3.5Mpa / 7Mpa
Blocks per m ² :	12.5
Weight per block:	14kg
Bricks per pallet:	100 = 1400 KG PER PALLET – 22 pallets per load

M200 BLOCK



Dimensions:	390[L] x 190[W] x 190[H]
Strength:	3.5 Mpa /7Mpa
Blocks per m ² :	12.5
Weight per block:	16.3kg
Bricks per pallet:	75 = 1222 KG PER PALLET – 26 pallets per load

COMMON BRICK



Dimensions:	210 [L] x 75 [W] x 100 [H]
Tensile Splitting Strength:	7 Mpa /14Mpa
Weight per brick:	3.2kg
Bricks per m ² :	56
Bricks per pallet:	500 = 8.93 m ² = 1600 kg per pallet – 20 pallets per load

MAXI BRICK – SOLID - NFP AND NFX



Dimensions:	210 [L] x 90 [W] x 100 [H]
Strength:	7 Mpa /14Mpa
Weight per brick:	4.5 kg
Bricks per m ² :	35
Bricks per pallet	404= 11.54 m ² = 1818 kg per pallet – 18 pallets per load

MAXI BRICK – HOLLOW - NFP AND NFX



Dimensions:	210 [L] x 90 [W] x 100 [H]
Strength:	7 Mpa /14Mpa
Weight per brick:	3.4 kg
Bricks per m ² :	35
Bricks per pallet	404 = 11.54 m ² = 1374 kg per pallet – 22 pallets per load



AMALGAMATED CONCRETE

LINTELS

All lintels are available from 900mm to 6m in 300mm increments. Longer lengths are available on request.

BRICK LINTELS

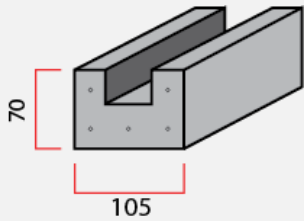

Dimensions:	105mm [W] x 70mm [H]
Tensile Splitting Strength:	40 Mpa
Weight per meter:	15.5 KG / M
Meter per 13 ton:	770 m
WIRE:	3 < 4 wire 3.3 > 5 wire

BLOCK LINTELS

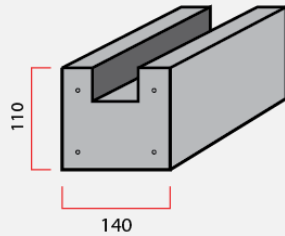

Dimensions:	140[W] x 110[H]
Tensile Splitting Strength:	40 Mpa
Weight per meter:	24 kg /m
Meter per 13 ton:	500 m
WIRE:	3 < 5 wire 3.3 > 7 wire

MAXI LINTELS

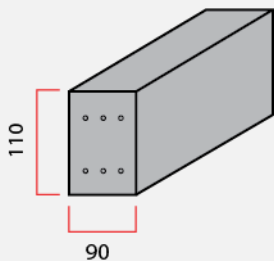

Dimensions:	90mm [W] x 110mm [H]
Tensile Splitting Strength:	40 Mpa
Weight per meter:	18.3 kg /m
Meter per 13 ton:	650 m
WIRE:	3 < 4 wire 3.3 > 5 wire

S BLOCK LINTELS

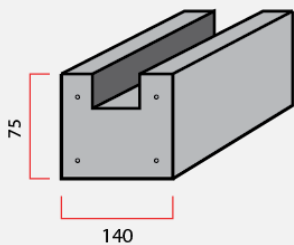

Dimensions:	140mm [W] x 75mm [H]
Tensile Splitting Strength:	40 Mpa
Weight per meter:	17 kg /m
Meter per 13 ton:	700 m



AMALGAMATED CONCRETE

Miscellaneous

SINGLE WASH TROUGH

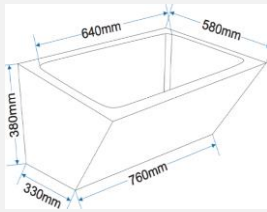
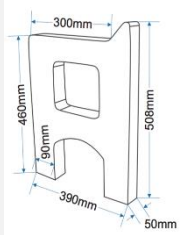

Dimensions: 760[L] x 320[W] x 360+460 [H]

Weight: 162kg



DOUBLE WASH TROUGH

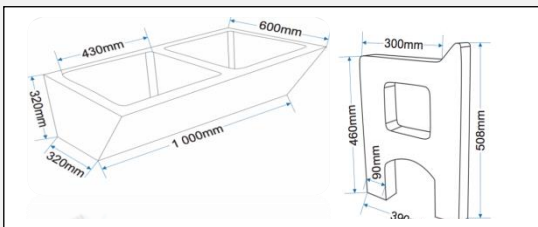

Dimensions: 1000[L] x 600 [W] x 320 + 460 [H]

Weight: 184kg



GULLEYS

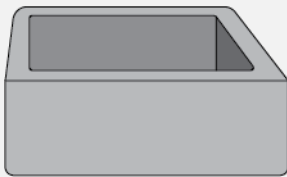

Dimensions: 350[L] x 350[W] x [H]

Strength: 20 Mpa

Weight: 17 kg

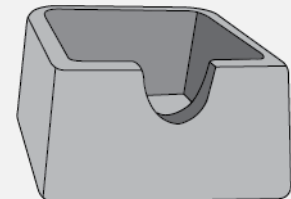

SURFACE WATER CHANNEL



Dimensions: 1000[L] x 270[W] x 90[H]

Weight : 63.6 kg

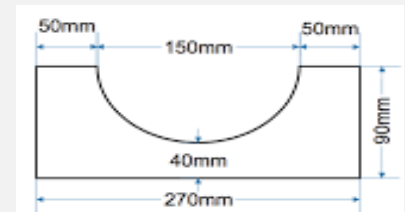

STOP END WATER CHANNEL



Dimensions: 620 [L] x 285[W] x 90/100 [H]

Weight: 50 kg



AMALGAMATED CONCRETE

Grass Blocks

Grass blocks are the new generation driveway and parking lot alternative. This eco-friendly green product is designed to give maximum load bearing below and allow maximum grass coverage on the surface.

Amalgamated Concrete produce heavy duty grass blocks, extremely robust and able to withstand trucks yet giving a natural look for your driveway or parking lot, which can be mowed.

Installation is easy as there are 4 blocks per m², making them cost effective to lay.

- Dimensions: 497 x 476 x 90 reinforced
- Weight: 42 kg - 10 Blocks per pallet
- Blocks per m²: 4

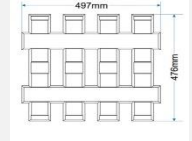
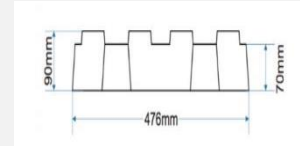

Grass Blocks

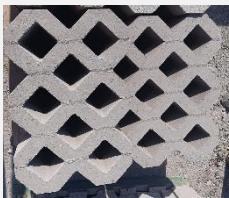

- Dimensions: 600[L] x 400[W] x 100[H]
- Weight: 38kg - 32 blocks per pallet
- Blocks per m²: 4.2



Dog Bone

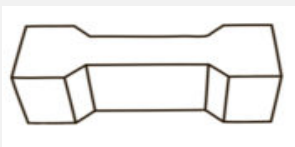

- Dimensions: 310[L] x 95[W] x 60[H]
- Weight: 22kg

RETAINER BLOCK



- Dimensions: 300[L] x 400[W] x 220 / 200 [H]
- Weight: 35kg - 32 blocks per pallet
- Blocks per m²: Approximately 7 blocks per m²
Approximately 2.2 per running meter

STEPS



- Dimensions: 1000[L] x 350[W] x 180[H]
- Strength: 40 Mpa
- Weight: 56kg



AMALGAMATED CONCRETE

KERBS

FIG 6



Dimensions: 1000[L] x 230[H] x 125/75[W]
Strength: 40 Mpa
Weight: 54kg
Kerbs per pallet: 25

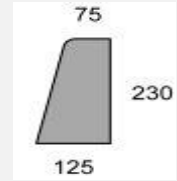
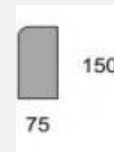

Fig 12



Dimensions: 1000[L] x 75[W] x 150[H]
Tensile Splitting Strength: 40 Mpa
Weight per brick: 22kg
Kerbs per pallet: 50



GARDEN KERBS



IN 1-F12

NEW

Dimensions: 750[L] x 75[W] x 100[H]
Tensile Splitting Strength: 40 Mpa
Weight per kerb: 12kg
Kerbs per pallet: 100



AMALGAMATED CONCRETE

COVER BLOCKS

A cover block is basically a spacer that is used to lift the rebar matrix off the ground so that concrete may flow underneath the rebar.

SIZES AVAILABLE: 75mm, 50mm, 40mm, 30mm

Cover Blocks are used:

1. To maintain a specified spacing between the rebar and the shuttering.
2. To prevent the steel reinforcement bars from environmental effects to protect their corrosion.
3. To furnish thermal insulation, which prevents the reinforcement bars from fire.
4. To provide reinforcing bars sufficient embedding to enable them to be stressed without slipping.

Size of Cover Blocks for Structural Members

Listed below is the size of cover blocks for different structural members which are normally used in construction.



- Size of Cover Blocks for Beam = Minimum 20 mm
- Size of Cover Blocks for Column = Minimum 40 mm
- Size of Cover Blocks for Footing = Minimum 50 mm
- Size of Cover Blocks for Shear Wall = Minimum 30 mm
- Size of Cover Blocks for Retaining Wall = Minimum 20 mm
- Size of Cover Blocks for Staircase = Minimum 15 mm

DUSTBIN

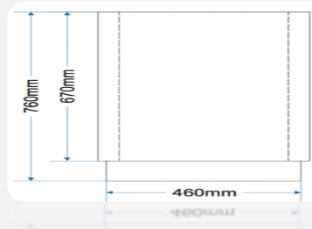
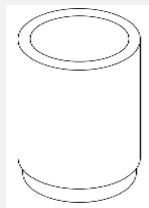
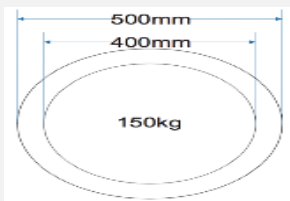

Dimensions:

480[W] 750[H]

Weight:

142 kg

UMBRELLA BASE

30 KG



45 KG





AMALGAMATED CONCRETE

CAPPINGS PYRAMID

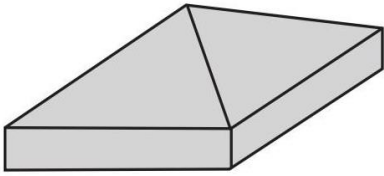

Standard Sizes available

Dimensions: 450 x 450

Weight: 55 kg

Dimensions: 580 x 580

CONE

Standard Sizes available

Large: 450 x 450

Weight: 84.45 kg



Medium: 400 x 400

Weight: 53.9 kg

PALISADE FENCING

PALE

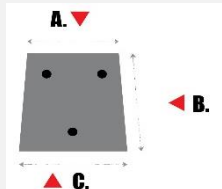

LENGTH: 2400MM

A = FRONT: 80MM

B = WIDTH: 75MM

C = REAR: 95MM

POLE

LENGTH: 3000MM

A = FRONT: 80MM

B = WIDTH: 225MM

C = REAR: 130MM

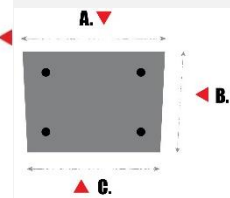
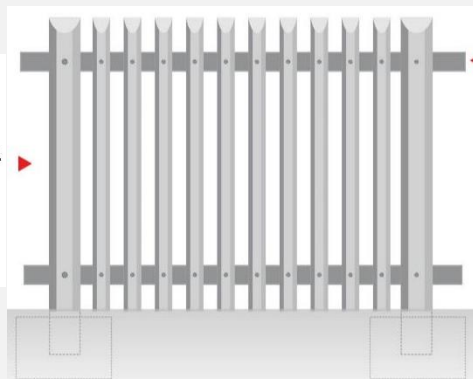
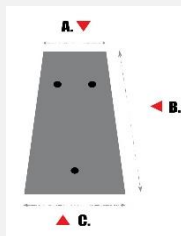

RAIL / CROSS BAR

LENGTH: 2000MM

A = FRONT: 155MM

B = WIDTH: 85MM

C = REAR: 150MM



AMALGAMATED CONCRETE

INTERLOCKING PAVERS

Interlocking Pavers are ideally shaped to distribute concentrated heavy loads so that the underground material is no as distressed as when a rigid surface had been used.

Commercial Interlocking Pavers provide durable surfaces that can be used in a variety of ways to enhance the appearance and functionality of any landscape.

AVAILABLE COLOURS:

Colors may vary from picture due to picture display properties.

Grey

Charcoal

Burgundy / plum

Brown

Sandstone / Tan



80mm Interlocking Paver Bricks



DESCRIPTION

Dimensions:	200 [L] x 100 [W] x 80mm [H]
Strength:	20Mpa / 30Mpa
Weight per brick:	3.3kg
Bricks per m ² :	49
Bricks per pallet:	400 = 8.16m ² = 1320 KG PER PALLET – 24 pallets per load

60mm Interlocking Paver Bricks



DESCRIPTION

Dimensions:	200m [L] x 100 [W] x 60mm [H]
Strength:	20Mpa / 30Mpa
Weight per brick:	2.8kg
Bricks per m ² :	49
Bricks per pallet:	600 = 12.24 m ² = 1680 KG PER PALLET – 19 pallets per load



AMALGAMATED CONCRETE

COBBLE PAVERS

COLOURS: CHARCOAL, TERRACOTTA, NATURAL

Dimensions: 110 x 110 x 50
Weight: 1.4 kg
Per Pallet: 810 = 10m²



Dimensions: 160 x 160 x 50
Weight: 2 kg
Per Pallet: 390 = 10m²

FLAGSTONE PAVERS

AVAILABLE SIZES:

200 X 200
400 X 200
400 X 400
450 X 450
500 X 500

COLOURS: CHARCOAL, TERRACOTTA, NATURAL



LARGE PAVERS



SIZE 1000 X 1000 X 45
WEIGHT: 98 KG



SIZE 1000 X 500 X 42
WEIGHT: 51 KG





AMALGAMATED CONCRETE

COLLUMNS

We supply the following columns:

Hollow Column with Cap and Base	2.1 m x 220 DIA
Round Column with Cap and Base	2.1 m x 220 DIA
Venetian Column	2.1 m x 220 DIA
Scroll Column	2.4 m x 220 DIA
Twisted Column	2.1 m x 220 DIA
Twisted Column Large	